

Technical Explanations for DC Solenoids

1

Product group

G XX

Contents

| | | | | | |
|--------------------------------------|--|-------|--|---|----|
| 1. Types of DC Solenoids..... | 3 | 2.2.3 | Stroke end position | 7 | |
| 1.1 | Linear solenoids..... | 3 | 2.3 | Magnetic force vs. stroke characteristic, torque vs. rotation angle characteristic | 7 |
| 1.1.1 | Designs..... | 3 | 2.4 | Adjustment of magnetic force vs. stroke characteristic to specific strokes (stroke adjustment) | 8 |
| 1.1.2 | Movement types | 3 | 2.5 | Linear work | 8 |
| 1.1.3 | Components | 4 | 2.5.1 | Linear work | 8 |
| 1.2 | Rotary solenoids, ON/OFF (ON/OFF rotary solenoid) .. | 4 | 2.5.2 | Rated work | 8 |
| 1.2.1 | Designs..... | 5 | 3. Electrical Parameters and Terms | 8 | |
| 1.2.2 | Movement types | 5 | 3.1 | Rated voltage..... | 8 |
| 1.2.3 | Components | 5 | 3.2 | Voltage change | 8 |
| 1.3 | Proportional rotary solenoids..... | 5 | 3.3 | Rated current..... | 8 |
| 1.3.1 | Designs..... | 5 | 3.4 | Test current | 8 |
| 1.3.2 | Movement types | 5 | 3.5 | Rated power | 8 |
| 1.4 | Holding magnets..... | 5 | 4. Terms of Time and Operating Modes | 9 | |
| 1.4.1 | Designs..... | 6 | 4.1 | Duty cycle | 9 |
| 1.4.2 | Function types | 6 | 4.2 | Current-less interval..... | 9 |
| 1.4.3 | Components | 6 | 4.3 | Cycle time | 9 |
| 1.5 | Description of components | 6 | 4.4 | Cycle sequence | 9 |
| 1.5.1 | Excitation winding..... | 6 | 4.5 | Relative duty cycle..... | 9 |
| 1.5.2 | Armatures | 6 | 4.6 | Working cycle | 9 |
| 1.5.3 | Functional parts | 6 | 4.7 | Switching frequency..... | 9 |
| 1.5.4 | Solenoid bodies | 6 | 4.8 | Operating modes | 9 |
| 1.5.5 | Permanent magnets | 6 | 4.8.1 | Continuous operation..... | 9 |
| 2. Mechanical Parameters..... | 6 | 4.8.2 | Intermittent operation..... | 9 | |
| 2.1 | Force, torque | 6 | 4.8.3 | Short-time duty | 9 |
| 2.1.1 | Magnetic force | 6 | 5. Selection of Solenoids for the Different Rated Operating Modes | 9 | |
| 2.1.2 | Stroke force | 7 | 5.1 | Continuous operation..... | 9 |
| 2.1.3 | Holding force..... | 7 | 5.2 | Intermittent operation..... | 9 |
| 2.1.4 | Residual holding force | 7 | 5.3 | Short-time duty | 10 |
| 2.1.5 | Restoring force resp. restoring moment | 7 | | | |
| 2.2 | Stroke, rotation angle..... | 7 | | | |
| 2.2.1 | Solenoid stroke / rotation angle | 7 | | | |
| 2.2.2 | Stroke start position | 7 | | | |

| | | | | | |
|---|---|---|--|---|----|
| 6. Attraction and Fall Times, Possibilities to Influence the Attraction Time | 10 | 9.3 | Ambient air..... | 14 | |
| 6.1 | Attraction and fall times | 10 | 9.4 | Relative humidity | 14 |
| 6.1.1 | Attraction time..... | 10 | 9.5 | Installation guidelines and safety instructions..... | 14 |
| 6.1.1.1 | Response delay | 10 | 9.6 | Deviations operating conditions..... | 14 |
| 6.1.1.2 | Stroke time..... | 10 | 10. Service Life | 14 | |
| 6.1.2 | Fall time | 10 | 11. Electrical Connection of DC Solenoids | 14 | |
| 6.1.2.1 | Response delay | 10 | 11.1 | DC Connection | 14 |
| 6.1.2.2 | Return time | 10 | 11.2 | AC Connection..... | 14 |
| 6.1.3 | Attraction and fall times | 10 | 11.3 | Connection of DC solenoids via an electrical control device | 15 |
| 6.2 | Influence possibilities of attraction time | 10 | 11.3.1 | Maximising of the attraction force | 15 |
| 6.2.1 | Fast excitation..... | 10 | 11.3.2 | Optimising of energy efficiency and reduction of heat development | 15 |
| 6.2.2 | Over-excitation..... | 10 | 12. Note to the Elimination of Disconnect Overvoltage and Spark Quenching | 16 | |
| 6.2.2.1 | Series resistor with bypass switch | 10 | 12.1 | Elimination of disconnect over-voltages | 16 |
| 6.2.2.2 | Series resistor with capacitor..... | 11 | 12.1.1 | Damping by varistors | 16 |
| 6.2.2.3 | Control via electronical switching device | 11 | 12.1.2 | Damping by mains rectifier | 16 |
| 7. Temperatures, Thermal Classes of Insulating Materials and Cooling Types..... | 11 | 12.1.3 | Damping by diodes | 16 | |
| 7.1 | Temperature terms..... | 11 | 12.2 | Spark quenching..... | 16 |
| 7.1.1 | Ambient temperature | 11 | 13. Electromagnetic Time Constant (τ) und Inductances | 16 | |
| 7.1.2 | Steady-state temperature | 11 | 14. Order Specifications for DC Solenoids | 16 | |
| 7.1.3 | Reference temperature | 12 | 15. Installation Guidelines for DC Solenoids | 17 | |
| 7.1.4 | Limit temperature..... | 12 | 15.1 | General..... | 17 |
| 7.1.5 | Excessive temperature | 12 | 15.2 | Working position | 17 |
| 7.1.6 | Steady-state excessive temperature | 12 | 15.3 | Installation..... | 17 |
| 7.1.7 | Temperature rise limit | 12 | 15.4 | Initial operation | 17 |
| 7.1.8 | Hot spot difference..... | 12 | 15.5 | External counter-forces..... | 17 |
| 7.1.9 | Normal operating temperature..... | 12 | 15.6 | Electrical safety device | 17 |
| 7.2 | Thermal classes..... | 12 | 15.7 | Voltages drop and wire cross-section | 17 |
| 7.3 | Cooling types | 12 | 15.8 | Protection against contact | 17 |
| 7.4 | Measurement of the winding temperature by resistance measuring..... | 12 | 15.9 | Maintenance | 17 |
| 7.5 | Protection classes..... | 13 | 15.10 | Disassembly and disposal | 17 |
| 7.5.1 | Protection class I – Protective conductor system | 13 | 16. Safety..... | 18 | |
| 7.5.2 | Protection class II – Reinforced insulation..... | 13 | 16.1 | Safety instructions | 18 |
| 7.5.3 | Protection class III – Safety extra-low voltage | 13 | 16.2 | Note to functional safety | 18 |
| 8. Test of Electric Strength | 14 | 17. Protection classes of the devices | 18 | | |
| 8.1 | Type and level of test voltage | 14 | 17.1 | Designation protection classes | 18 |
| 8.2 | Performance of voltage test..... | 14 | 17.2 | Degrees of protection | 19 |
| 8.3 | Repeated voltage test..... | 14 | 17.3 | Solenoids for the application under special conditions..... | 20 |
| 9. Rated Operating Conditions..... | 14 | 18. Regulations, Standards and Provisions..... | 20 | | |
| 9.1 | Ambient temperature | 14 | | | |
| 9.2 | Altitude..... | 14 | | | |

1. Types of DC solenoids

Depending on the movement type, solenoids for direct current are classified in MSM programme into

- Linear solenoids



Fig. 1: Linear solenoids

- Rotary solenoids



Fig. 2: Rotary solenoids

Linear and rotary solenoids are control solenoids where the linear resp. rotary movement is realised by the effect of the magnetic field generated by the excitation winding.

- Holding magnets



Fig. 3: Holding magnets

Holding magnets are components which create a magnetic field for holding of ferromagnetic objects.

1.1 Linear Solenoids

The DC linear solenoids contained in the MSM programme are plunger solenoids where the operating air gap is located between core and armature inside the excitation winding, the armature plunges into the excitation winding.

By a special design of armature and core in the area of the working air gap, the magnetic energy is largely used to generate the linear work.

1.1.1 Designs

Distinction is made between **2 designs**:

- a) The solenoid body encloses the excitation winding multi-directionally, closed design (Fig. 4)

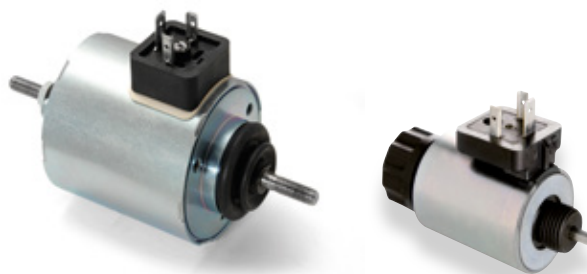

Fig. 4: closed control solenoids

- b) The solenoid body encloses the excitation winding only partly, open design (Fig. 5)



Fig. 5: Single-acting solenoid in open design

Whereas the closed design a) is always used there where highest technical demands are placed regarding linear work, protection class and service life, the open design b) satisfies mainly the applications where the technical demands can be reduced.

1.1.2 Movement types

Depending of the movement type, distinction is made between single-acting, double-acting and reverse solenoids:

- a) **Single-acting solenoids** (Fig. 6) are solenoid where the movement from the initial position to the end position is made by electromagnetic force effect. To return to the initial position, an external force is required e.g. spring force, weight force etc.

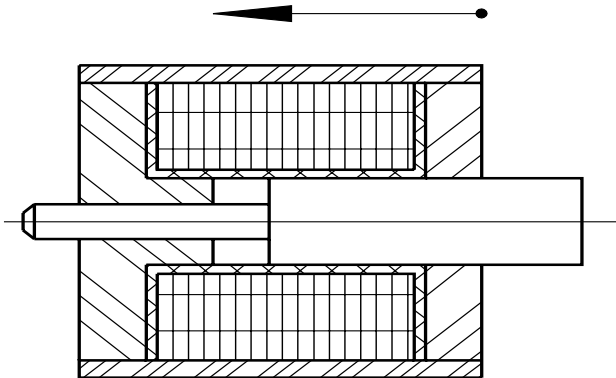

Fig. 6: Principle single-acting solenoid

- b) **Double-acting solenoids** (with zero position) (Fig. 7) are solenoids where after excitation of the relevant coil, the movement is made from zero position in one of both opposite directions. Reset in zero position is made after switching off by external restoring forces. So, the zero position is the initial position for both directions.

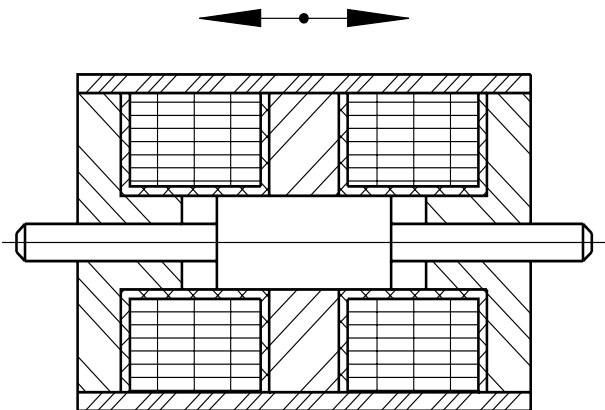

Fig. 7: Principle double-acting solenoid

- c) **Reverse solenoids** (without zero position) (Fig. 8) are solenoids where the movement is made after excitation of the relevant coil from one end position in the other or vice versa.

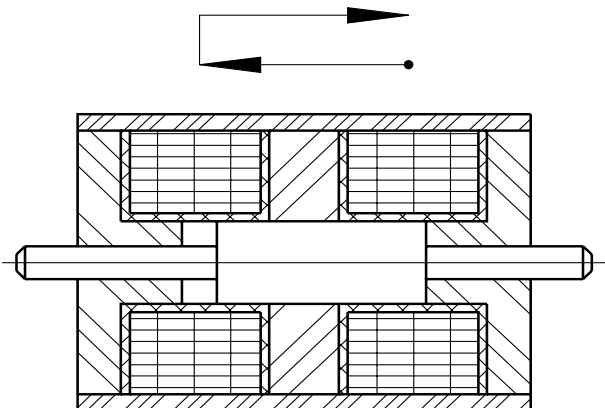

Fig. 8: Principle reverse solenoid

1.1.3 Components

The main components of MSM DC control solenoids are: (Fig. 9)

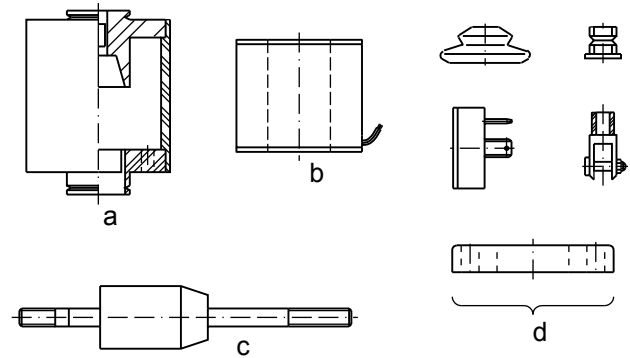

Fig. 9: Main components linear solenoid

- a) Solenoid body
- b) Excitation winding
- c) Armature
- d) Functional parts

1.2 Rotary solenoids, ON/OFF (ON/OFF rotary solenoid)

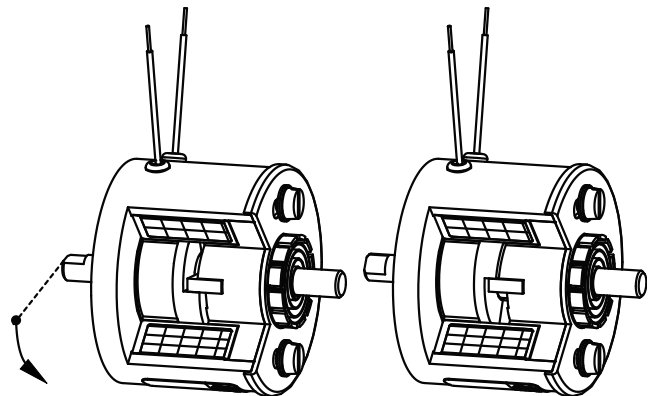

Fig. 10: Cross section ON/OFF rotary solenoid

For the DC rotary solenoids contained in the MSM programme, the armature is prevented from an axial movement by a suitable bearing. The special geometry of armature and core divides the linear force into one radial and one axial component.

The radial force sets the shaft in motion and can be obtained as torque.

Due to the design, the axial force component is not utilised. So, only a part of the magnetic energy is converted into linear work resp. "rotary work" in this case.

For applications where a better utilisation of the magnetic energy is required, proportional rotary solenoids type G DR are ideal which are working according to a more effective but more elaborate operating principle.

1.2.1 Designs



Fig. 11: Rotary solenoid type G DA

Rotary solenoid type G DC

ON/OFF rotary solenoids are provided in round and square design. Whereas the round design (type G DA) is the common and therefore the preferred one, higher torques are achieved with the square design due to the more massive magnetic circuit (type G DC).

1.2.2 Movement types

For ON/OFF rotary solenoids, the single-acting type is the most popular.

If a reset is required, a return spring is adapted by a suitable spring cage.

In general, a version as reverse rotary solenoid with 2 rotary solenoids working together in contrary motion can be realised as special design in analogy to the linear solenoids.

If necessary, we recommend checking, if our proportional rotary solenoids type G DR can be applied. Here, the reversal of the rotation direction can be achieved by reversing the polarity of the electrical connection.

1.2.3 Components

The main components of MSM DC rotary solenoids are: (Fig. 12)

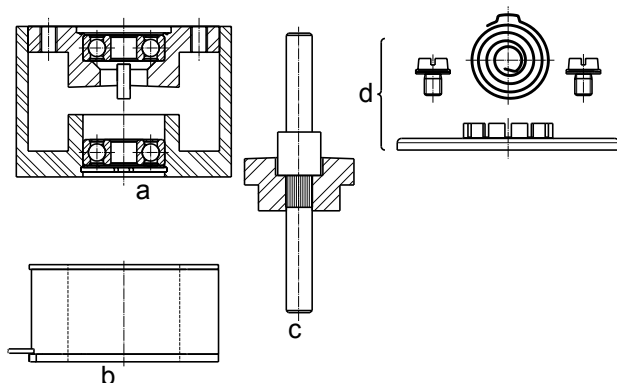

Fig. 12: Main components rotary solenoid

- a) Solenoid body with ball bearing
- b) Excitation winding
- c) Armature
- d) Functional parts (return spring and spring cage)

1.3 Proportional Rotary Solenoids

Proportional rotary solenoids are subject to an electrodynamic operating principle. In front of the pole surface of a solenoid, there is a permanent magnet disc, rotatable and axially fixed, pivoted with constant air gap. Depending on the current flowing through the coil, a torque builds up which is nearly constant throughout the rotation angle. By switching the polarity, the direction of rotation can be reversed.

The main components of MSM proportional solenoids are: (Fig. 13)

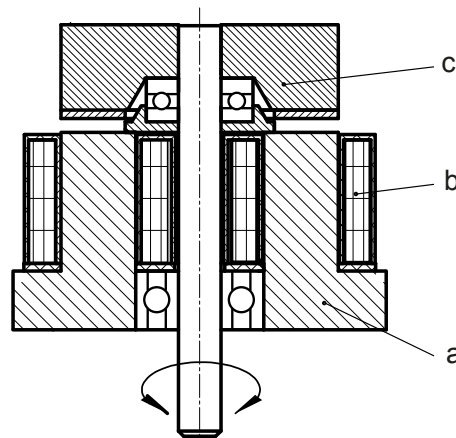

Fig. 13: Principle proportional rotary solenoid G DR

- a) Solenoid body
- b) Excitation winding with ball bearing
- c) Armature with permanent magnet disc

1.3.1 Designs



Fig. 14: Proportional rotary solenoid type G DR

Proportional rotary solenoids are exclusively provided in round design. In general, other housing designs are possible as special solution for an ideal adaption to the application.

1.3.2 Movement types

For the proportional rotary solenoids, the direction of rotation is determined by the polarity of the electrical connection. If a change of the direction of rotation is not possible by reversing the polarity or not wanted, reset can be made in analogy to the ON/OFF rotary solenoid by an external force or by a spring.

1.4 Holding magnets

Holding magnets are DC solenoids generally performing no or only a very low stroke. With holding magnets, the magnetic force decreases quickly with increasing distance of the pole surface to the counter piece

due to the double air gap. The holding force acts on all ferromagnetic materials. Ideally, an armature with gimbal bearing is used as counter piece because it equalises direction errors and misalignments.

1.4.1 Designs

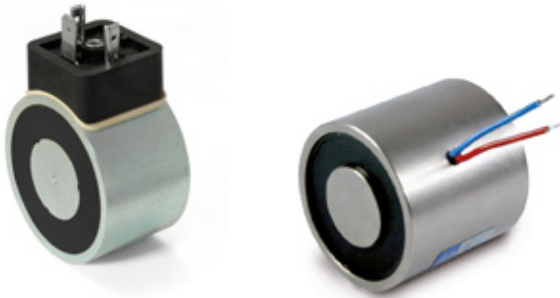

Fig. 15: Holding solenoid

Permanent holding solenoid

Holding solenoids are provided as standard products exclusively in round design. In general, other designs are possible as special designs.

1.4.2 Function types

Holding solenoids can be executed with and without permanent magnet.

- The **holding magnet** builds up its holding force, if the supply voltage is applied. If it is separated from the supply voltage, the magnetic field breaks down and the holding force does not act anymore.
- The **permanent holding magnet** is equipped with a permanent magnet and a coil. The holding force generated by the permanent magnet acts constantly. If the coil is energised with the correct polarity, the magnetic field of the coil neutralises the magnetic field of the permanent magnet, the holding force decreases to a minimum. With energising with reversed polarity, the magnetic field of the permanent magnet is reinforced, the holding force increases.

1.4.3 Components

The main components of MSM holding magnets/permanent magnets are: (Fig. 16)

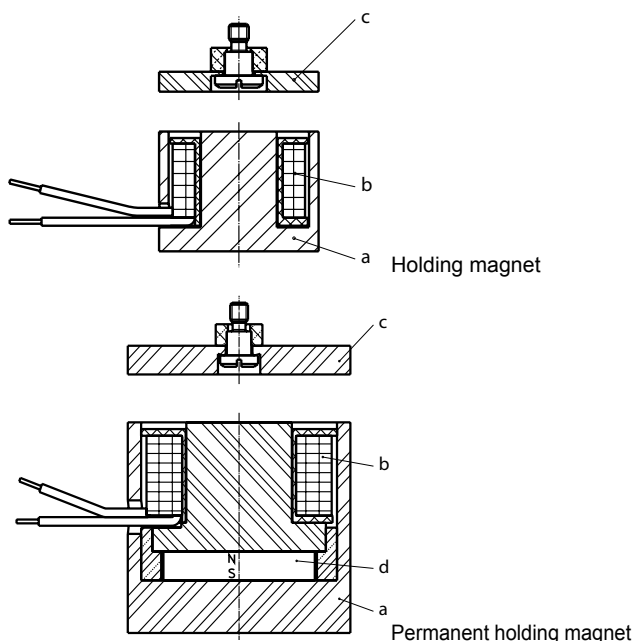

Fig. 16: Components holding magnet/permanent holding magnet

- Solenoid body
- Excitation winding
- Armature
- Permanent magnet

1.5 Description of Components

1.5.1 Potentially, the **solenoid body** consists of several single parts and is made of magnetically well conductive materials. The solenoid body undertakes different tasks depending on device and type.

- Guidance of the magnetic field in the magnetic circuit
- Mechanical encapsulation of the coil
- Mechanical structure for support of bearings and functional parts

1.5.2 Excitation winding is a coil made of enamelled copper wire. It takes the electrical energy to generate the magnetic field.

The quality of the used insulation materials and their thermal class is also crucial for the performance of the solenoid.

1.5.3 Armature is the part which is plunging through the magnetic field into the excitation winding resp. held in or through the magnetic field of the excitation winding; generally, it is guided in maintenance-free bearings with low clearance.

1.5.4 Functional parts are such parts which are not directly required for the generation of the magnetic force, but which must be available for the practical operation of the solenoid. These include e.g. for the mechanical utilisation of the magnetic force: stroke limitations, stops, pressure bars and draw bars, fork joints etc. and for the electrical connection of the excitation winding: cable connectors, terminal boxes, connector systems etc.

1.5.5 Permanent magnets are made of materials which permanently keep their magnetic field after a one-time magnetisation.

If permanent magnets are integrated in the magnetic circuit of a DC solenoid, you receive a polarised system. In this case, the correct polarity of the voltage supply is to be ensured.

2. Mechanical Parameters

The symbols and SI units used in den data sheets und technical explanations comply with DIN 1304-1.

2.1 Force, torque

2.1.1 Magnetic force F_M is the utilisable part - thus reduced by the friction - of the mechanical force generated in the linear solenoid in stroke direction with horizontal armature position. (Fig. 17) For rotary solenoids, the **torque M_a** applies by analogy as utilisable parameter.

It refers to the normal operating condition of the excitation winding and to 90 % of the rated voltage.

With operation with nominal value of the rated voltage, the list values increase by approx. 20 %.

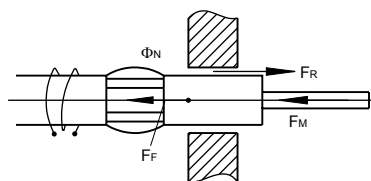

$$F_M = F_F - F_R$$

Fig. 17: Magnetic force

Φ_N = utilised flow

F_R = friction force

F_M = magnetic force

F_F = force acted by the magnetic field on the armature

The determination of the normal operating condition and/or the steady-state temperature ϑ_{23} is based on the most unfavourable conditions encountered in practical use. If the solenoids are mounted on a well conductive base (e.g. machine beds, frame parts of steel, metal chassis etc.) in practice, the magnetic force can be increased particularly by adjusting the excitation power of the winding to the respective operating conditions. A further increase of the magnetic force is possible, if the ambient temperature is constantly below the upper ambient temperature ϑ_{14} of +35° C. Conversely, the electrical excitation power must be reduced, if the ambient temperature is constantly higher than +35° C which is related to a reduction of the magnetic force.

An optimal adjustment of the solenoid to the ambient conditions is made within the scope of an application-specific winding design. This is possible as special version on request. If required, please complete our check list solenoid technology for this.

Our technical offices are pleased to support you.

2.1.2 Stroke force F_H (Fig. 18 and Fig. 19) is the magnetic force which acts outwards under consideration of the appropriate component of the armature weight F_A .

For rotary solenoids, this term is not relevant, because installation position and armature weight do not impact the torque.

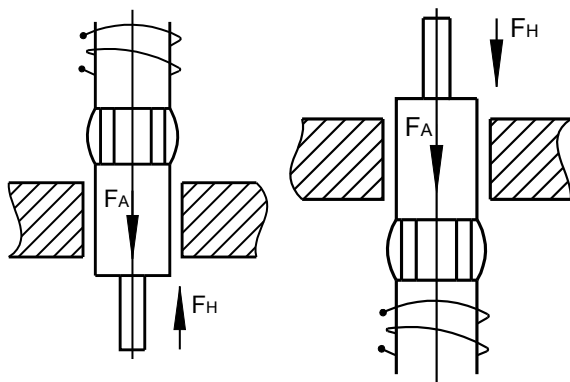

$$F_H = F_M - F_A$$

$$F_H = F_M + F_A$$

$$F_A = m_A \cdot g$$

Fig. 18: Stroke force from bottom to top pulling or pushing

F_A = weight force of the armature

m_A = armature mass

$$g = 9,81 \frac{m}{s^2}$$

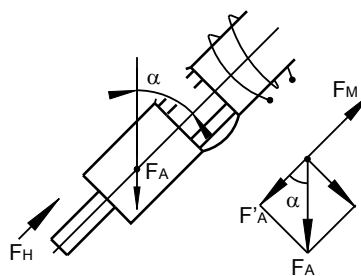

$$F_H = F_M - F'_A$$

Fig. 19: Stroke force from bottom to top pulling or pushing diagonally

$$F'_A = F_A \cdot \cos \alpha$$

F_M = magnetic force

F_H = stroke force

2.1.3 Holding force is the magnetic force in stroke end position, thus with stroke 0.

For rotary solenoids, the holding torque is the torque in end position (max. rotation angle)

2.1.4 Residual holding force is the holding force which remains after switching off the current.

Due to their design, rotary solenoids have a residual air gap in the end position which prevents a residual holding torque.

2.1.5 Resetting force resp. **self-aligning torque** are required values after a cut-off for the return of the armature in the start position.

2.2 Stroke, rotation angle

2.2.1 Solenoid stroke s / rotation angle is the distance/angle travelled by the armature between start position and end position.

2.2.2 Stroke start position s_1 is the start position of the armature before beginning the stroke movement resp. after termination of resetting.

2.2.3 Stroke end position s_0 (see also abszissa zero in Fig. 20) is the position of the armature designed in the device which the armature takes due to the electromagnetic force effect.

2.3 Magnetic force vs. stroke characteristic, torque-rotation angle-characteristic

In principle, there are three different types of characteristics (Fig. 20):

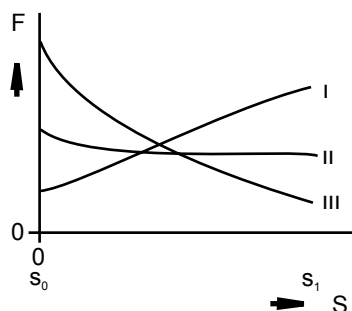

Fig. 20: Types of the magnetic force vs. stroke characteristic

I. falling characteristic

II. horizontal characteristic

III. increasing characteristic

The **magnetic force vs. stroke characteristics** of MSM DC solenoids can be controlled by respective setting of the solenoid system.

The most common are:

Increasing characteristic particularly suitable for spring counterforces

and the **horizontal characteristic** particularly suitable for constant counterforces.

The **falling characteristic** is rarely used for DC linear solenoids. Application areas are there where it shall be worked against huge friction forces.

Modifications of the characteristics shown in the data sheets are available as special designs on request.

With rotary solenoids, force F corresponds to torque M_d and stroke s corresponds to the rotation angle.

2.4 Adjustment of the magnetic force vs. stroke characteristic to specific strokes (stroke adjustment)

By special adjustment of the active solenoid parts controlling magnetic force vs. stroke characteristic, the solenoid strokes can be adjusted (reduced or extended) within quite wide limits without significant modifications of the linear work. That means an increase of the magnetic force for a stroke reduction, and a reduction of the magnetic force for a stroke extension. (Examples see Fig. 21)

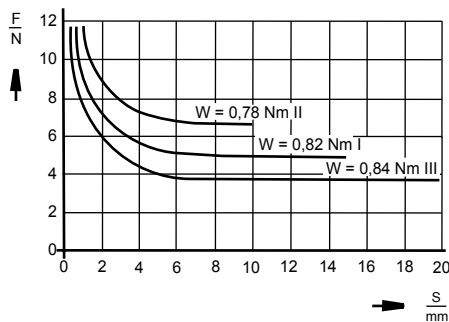

Fig. 21: Magnetic force vs. stroke characteristic with stroke adjustment

I Standard version

II Stroke reduction

III Stroke extension

2.5 Linear work

2.5.1 Linear work W is the integral of the magnetic force over the solenoid stroke (Fig. 22)

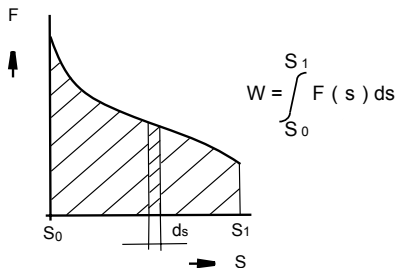

Fig. 22: Linear work at the magnetic force vs. stroke characteristic

2.5.2 Rated linear work W_N , specified in the data sheets is calculated as product of magnetic force F_M in stroke start position S_1 and the solenoid stroke s (Fig. 23)

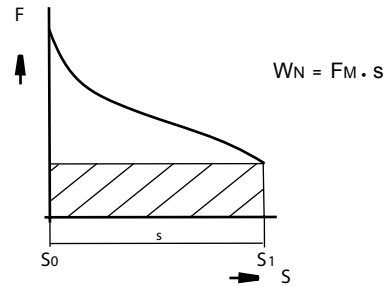

Fig. 23: Rated linear work at the magnetic force vs. stroke characteristic

3. Electrical Parameters and Terms

Unless stated otherwise, voltage and current data are arithmetic average values with direct current.

3.1 Rated voltage U_N is the voltage which a voltage device is designed for and it is indicated with.

The values specified in the data sheets are based on a rated voltage of 24 V, unless stated otherwise.

For other rated voltages, deviations from the specified magnetic forces may occur in the different insulation parts in the excitation windings, both upwards (mostly with > 24 V) or downwards (mostly with < 24 V).

3.2 Continuously admissible voltage change at DC solenoids is $\pm 10\%$ of the rated voltage.

3.3 Rated current I_B is the current set at rated voltage and at a temperature of the excitation winding of $+20^\circ\text{C}$.

It can be determined by division of the rated power specified in the data sheets by the rated voltage.

3.4 Test current I_{PR} is the current the magnetic force values specified in the data sheets refer to. It is calculated from:

$$I_{PR} = \frac{0,9 U_N}{R_W}$$

where R_W stands for the resistance of the excitation winding at operating temperature.

3.5 Rated power P_N specified in the data sheets refers to the rated voltage and the rated current. As rated current is based on a temperature of $+20^\circ\text{C}$, the rated power is called P_{20} at MSM. Unless specified otherwise, a rated voltage of 24 V is taken as a basis.

4. Time Terms and Operating Modes

4.1 **Duty cycle** t_s is the time when supply voltage is applied at the solenoid.

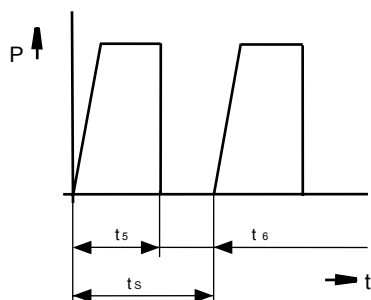

Fig. 24: Time terms to operating mode

t_s = duty cycle

t_6 = current-less interval

t_s = cycle time

P = power

t = time

4.2 **Current-less interval** t_6 is the time which is between switching off and restart of the voltage.

4.3 **Cycle time** t_s is the sum of duty cycle and current-less interval.

4.4 **Cycle sequence** is a one-time and periodically returning sequence of cycle time values of equal or different sizes.

4.5 **Relative duty cycle ED (%)**, is the das percentage ratio of duty cycle to cycle time.

$$\% \text{ ED} = \frac{\text{duty cycle}}{\text{cycle time}} \cdot 100$$

4.6 One **working cycle** comprises one complete switch-on and -off process.

4.7 **Switching frequency** is the number of working cycles evenly distributed over one hour.

4.8 Operating modes

The operating modes the DC solenoids can be designed for are:

4.8.1 Continuous operation (S 1)

The duty cycle is so long that the steady-state temperature is virtually achieved. (Fig. 25)

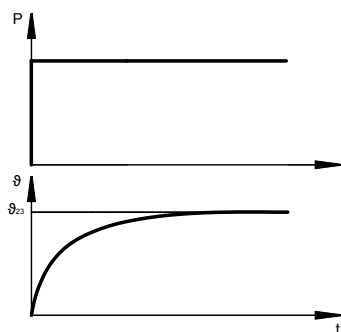

Fig. 25: Temperature curve continuous operation

4.8.2 Intermittent operation (S 3)

Duty cycle and current-less interval alternate in regular or irregular sequence where the intervals are so short that the device does not cool down to its reference temperature. (Fig. 26)

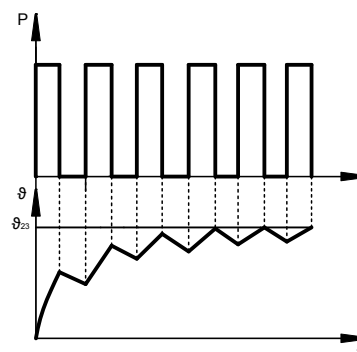

Fig. 26: Temperature curve intermittent operation

4.8.3 Short-time duty (S 2)

Duty cycle is so short that the steady-state temperature won't be reached. The current-less interval is so long that the device virtually cools down to reference temperature. (Fig. 27)

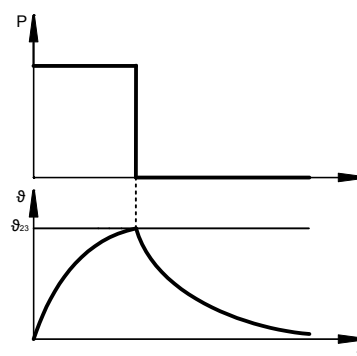

Fig. 27: Temperature curve short-time duty

5. Selection of Solenoids for the Different Rated Operating Modes

5.1 For **continuous operation (S 1)**, only a solenoid can be chosen which has an excitation winding designed for continuous operation = 100 % ED. It has to be observed that with continuous operating over a longer period, the solenoid is switched from time to time in order to avoid sticking of functional parts due to environmental influences (e.g. dirt, humidity...).

5.2 For **intermittent operation (S 3)**, considerably higher performances and therefore magnetic forces can be installed than with continuous operation.

Relative duty cycle, cycle time and thermal time constant of the solenoid are decisive for the admissible power to be installed.

Force values, power values, linear work values and time values specified in the data sheets refer to a **cycle time of 5 minutes (300 sec.)** For this cycle time, the maximum admissible values for the duty cycle are as follows:

| | | | | |
|--------------------------------------|----|----|----|-----|
| Relative duty cycle (% ED) | 5 | 15 | 25 | 40 |
| Admissible maximum duty cycle (sec.) | 15 | 45 | 75 | 120 |

Fig. 28: Duty cycle

If the admissible maximum duty cycle is exceeded, the solenoid for the next higher relative duty cycle is to be chosen. If the duty cycle exceeds 120 sec., the solenoid is to be designed for continuous operation = 100 % ED.

In particularly critical cases, it is possible to ideally adjust the installable electrical power and so the magnetic force for a certain relative duty cycle of the respective present cycle time and the given thermal time constant of the solenoid.

In these cases, we ask you to consult us.

5.3 For short-time duty (S 2), considerably higher performances can be installed, similar to intermittent operation, and so higher magnetic forces can be achieved. Also in these cases, we ask you to contact us and to indicate the exact operating conditions.

Short-time duty is identified by indicating the duty cycle e.g. „S2 20s“.

6. Attraction and Fall Times, Possibilities to Influence the Attraction Time

6.1 Attraction and fall times

The oscillogram serves to explain attraction and fall times and their components. (Fig. 29)

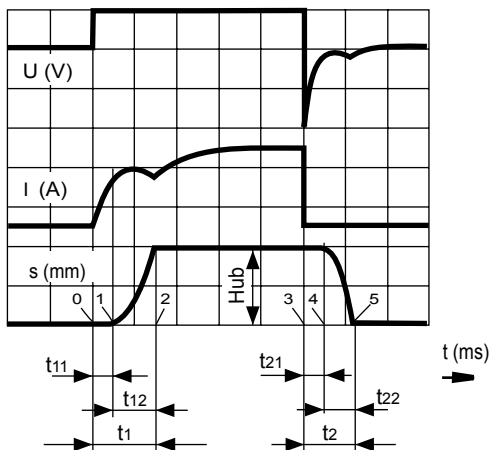

Fig. 29: Oscillogram switching process linear solenoid

6.1.1 Attraction time t_1 is the sum of response delay t_{11} and stroke time t_{12} (instant of time 0 until instant of time 2).

6.1.1.1 Response delay t_{11} is the period from switching on the current (instant of time 0) until the beginning of the armature movement (instant of time 1). In this period, the magnetic field builds up at that extent that it overcomes the external counterforce and sets the armature in motion.

6.1.1.2 Stroke time t_{12} is the period from the beginning of the armature movement (instant of time 1) until the achievement of the stroke end position (instant of time 2).

6.1.2 Fall time t_2 is the sum of response delay t_{21} and return time t_{22} (instant of time 3 until instant of time 5).

6.1.2.1 Response delay t_{21} is the period from switching off the current (instant of time 3) until the beginning of the return movement of the armature (instant of time 4). In this time, the magnetic field reduces to the extent that the armature is set in motion under the impact of the external counterforce.

6.1.2.2 Return time t_{22} is the period from the start of the return movement (instant of time 4) of the armature until the achievement of the stroke start position (instant of time 5).

6.1.3 The values of **attracting and fall times** indicated in the list were determined to DIN VDE 0580 in normal operating condition, at rated voltage and with 70 % of the rated magnetic force (weight load).

6.2 Influence possibilities of the attraction time

6.2.1 Fast excitation

By the series connection of an ohmic resistance and the respective increase of the supply voltage (Fig. 30), the electromagnetic time constant of the electric circuit is reduced and so also the attraction time is reduced.

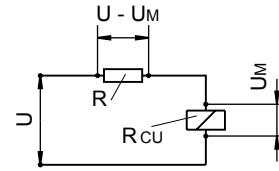

Fig. 30: Circuit diagram fast excitation

U = supply voltage

U_M = voltage at the solenoid

R = series resistor

R_{CU} = resistance of the excitation winding

In the diagram (Fig. 31), the reduction of the attraction time which is achieved by this measure is nearly indicated.

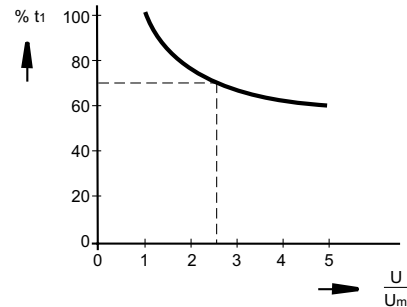

Fig. 31: Reduction attraction time depending on the voltage quotient

6.2.2 Over-excitation

With the attraction time reduction by over-excitation, the voltage is increased during the attraction time. The performance increase leads to an increase of the magnetic force. Depending of the level of over-excitation resp. of the attraction performance, serious attraction time reductions can be achieved.

The following switchings can be applied:

6.2.2.1 Series resistor with bypass switch (Fig. 32)

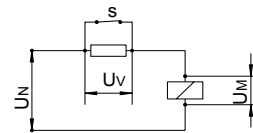

Fig. 32: Circuit diagram over-excitation with series resistor and bypass switch

U_N = rated voltage

U_M = voltage at the solenoid

U_V = voltage at the series resistor

S = switch

During the attraction process, resistance R_V is bridged by switch S . So, the solenoid receives the entire supply voltage. Only after reaching the stroke end position, or directly before, switch S is opened and the voltage at the solenoid is reduced to U_M by the voltage drop at the series resistor. Switch S can be actuated both by the solenoid itself and by an electronic circuit with time delay.

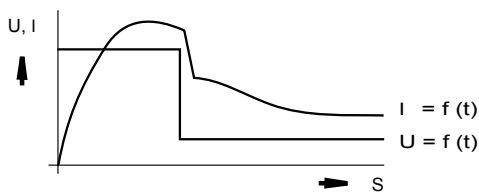

Fig. 33: Switch is actuated by solenoid

If the switch is actuated by the solenoid (Fig. 33), the switching point of the switch must be set very exactly just before the stroke end position, whereas when using a timer for safety reasons, a positive overlap of over-excitation time is possible (see Fig. 34) and so the arrangement becomes considerably less sensitive.

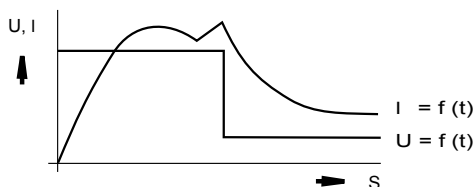

Fig. 34: Switch is actuated by delayed relay drive

6.2.2.2 Series resistor with capacitor

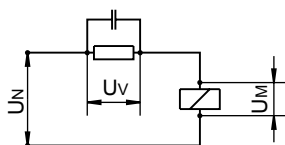

Fig. 35: Circuit diagram series resistor with capacitor

U_N = rated voltage

U_M = voltage at solenoid

U_V = voltage at series resistor

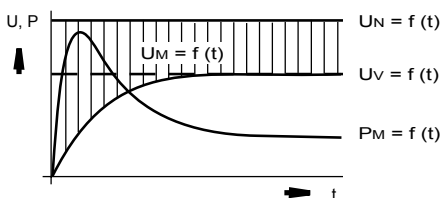

Fig. 36: Course of voltage and power for series resistor with capacitor

The voltage at the series resistor R increases slowly in accordance with the capacitor loading voltage and accordingly, the voltage at the solenoid decreases slowly. The power depending on the time runs according to an e-function, it has no jump function as described during the switching procedure. Accordingly, the excitation power for the excitation winding has a higher value at the beginning and already during the stroke process, it has a smaller value. Nevertheless, short attraction times can be achieved with this switching, if the capacitor has been correctly designed.

6.2.2.3 Actuation via electrical switching device

Via command by switch S, the actuation of the solenoid is made with high attraction voltage, so that during the attraction phase, a high electrical performance effecting a high magnetic force is available. Thus, the attraction time is considerably reduced. For the subsequent holding phase, the device switches to a lower holding voltage after an over-excitation time for the solenoid is not thermally overloaded.

When using this actuation type, control devices and solenoid are to be coordinated under consideration of the operating conditions. Please contact us, if required, we are pleased to advise you.

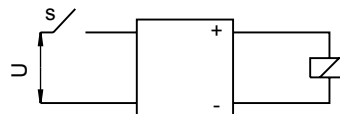

Fig. 37: Circuit diagram electrical switching device

S = switch

U = supply voltage

7. Temperatures, Thermal Classes of Insulating Materials and Cooling Types

7.1 Temperature terms:

Temperatures are indicated in °C, temperature differences in K.

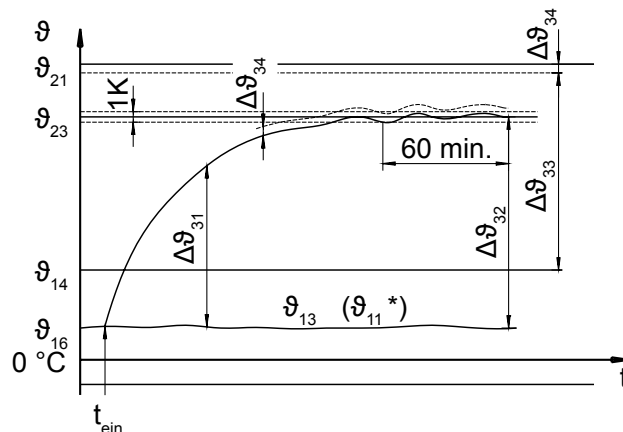

Fig. 38: Temperatures at solenoids

ϑ_{13} ambient temperature at the end of the measurement

ϑ_{11} reference temperature (consideration of temperature influences of media)

ϑ_{14} upper ambient temperature

ϑ_{16} initial temperature at the beginning of the measurement

ϑ_{21} upper limit temperature

ϑ_{23} steady-state temperature

$\Delta\vartheta_{31}$ excessive temperature

$\Delta\vartheta_{32}$ steady-state excessive temperature

$\Delta\vartheta_{33}$ temperature rise limit

$\Delta\vartheta_{34}$ hot spot difference

t_{ein} turn-on instant

* see section 7.1.3

7.1.1 Ambient temperature ϑ_{13} (in °C) of a device is the average temperature at specified locations of its environment at the end of the temperature measurement.

7.1.2 Steady-state temperature ϑ_{23} (in °C) of a device or of a part of it is the temperature occurring when heat produced by coil and dissipated heat are in balance.

7.1.3 Reference temperature ϑ_{11} (in °C) is the steady-state temperature in de-energised condition when used for the intended purpose and properly applied.

The reference temperature is no longer included in DIN VDE 0580 because it is assumed that the device reaches ambient temperature in de-energized condition at the end of the measurement. In practice, the reference temperature may deviate from the ambient temperature, e.g. during the assembly of a solenoid on a hydraulic slider where oil in normal operation temperature is passing through. If, however, there is no temperature impact by a medium, the **reference temperature ϑ_{11}** corresponds to the **ambient temperature ϑ_{13}** . In the standard, the design for DC solenoids is based on the reference temperature of 35°C. For hydraulic solenoids, heat input is usually effected by the medium, thus it is worked with a reference temperature of 50°C.

If an existing DC solenoid shall be applied at a deviating reference temperature, the duty cycle must be multiplied by the respective conversion factor. Depending on the reference temperature, it can be taken from table Fig. 39.

| Reference temperature (°C) | 20 | 35 | 40 | 50 | 60 | 70 | 80 |
|----------------------------------|-----|-----|-----|-----|-----|-----|-----|
| Conversion factor for duty cycle | 1,2 | 1,0 | 0,9 | 0,8 | 0,7 | 0,6 | 0,5 |

Fig. 39: Table conversion factor depending on the reference temperature

7.1.4 Upper limit temperature ϑ_{21} (in °C) is the highest admissible temperature for a device or a part of it.

7.1.5 Excessive temperature $\Delta\vartheta_{31}$ (in K) is the difference between the temperature of the device, or of a part of it, and the reference temperature.

7.1.6 Steady-state excessive temperature $\Delta\vartheta_{32}$ (in K) is the difference between the steady-state temperature ϑ_{23} and the ambient temperature ϑ_{13} resp. the reference temperature ϑ_{11} or also the excessive temperature ϑ_{31} at the end of a heating process.

7.1.7 Temperature rise limit $\Delta\vartheta_{33}$ (in K) is the admissible maximum value of the excessive temperature at rated operating conditions.

7.1.8 Hot spot difference $\Delta\vartheta_{34}$ (in K) is the difference between the average winding temperature and the hottest place of the excitation winding.

7.1.9 Normal operating temperature

Steady-state temperature ϑ_{23} is considered as **normal operating temperature** which adapts itself in the most unfavourable tolerance zone during the operation of the solenoid in compliance with the operating conditions (rated voltage, duty cycle, ambient temperature).

The most unfavourable operating conditions are:

- Maximum admissible ambient temperature
- Maximum rated voltage (rated voltage +10%)
- Maximum admissible runtime
- Operation on heat-insulating base
- Operation with windscreen (no cooling by convection)

7.2 Thermal classes

Insulators are divided into thermal classes according to their operating temperature resistance (see table Fig. 40).

During the determination of the temperature rise limits, a reference temperature of + 35°C and a hot spot difference of 5 K are taken as a basis for DC solenoids.

The thermal class is indicated for DC solenoids in the respective part list.

If special operating conditions should require other classes, please contact us.

| No. | Thermal classes | Upper limit temperature °C | Temperature rise limit K |
|-----|-----------------|----------------------------|--------------------------|
| 1 | Y | 90 | 50 |
| 2 | A | 105 | 65 |
| 3 | E | 120 | 80 |
| 4 | B | 130 | 90 |
| 5 | F | 155 | 115 |
| 6 | H | 180 | 140 |
| 7 | 200 | 200 | 160 |
| | 220 | 220 | 180 |
| | 250 | 250 | 210 |

Fig. 40: Table thermal classes of insulating materials

7.3 Cooling types

In principle, the cooling of a solenoid impacts the performance which has to be installed over the winding resistance.

There are the following cooling types:

- Cooling by quiet ambient air
- Cooling by moving ambient air
- Cooling by heat conduction
- Cooling by special cooling agents or surrounding media

Unless otherwise specified, MSM list devices are designed for the most unfavourable case of quiet ambient air on insulating base.

For more favourable cooling types (b, c, d), the steady-state excessive temperature will set itself below the upper limit temperature.

In these cases, it is possible to achieve higher performances and forces by a special winding.

Please contact us when required. We are pleased to work out an optimised solution for your application.

7.4 Measuring of the winding temperature by resistance measurement

If the operating conditions of a solenoid deviate considerably from the conditions specified in the data sheets, it is necessary to measure the winding temperature in the real application.

A measurement at the solenoid housing is not expedient, because it does not consider the thermal gradient inside the solenoid. Therefore, the winding temperature is usually determined by the change of the coil resistance.

- Measuring of the resistance R_k of the cold winding at ambient temperature ϑ_{16} .
- Determining of the ambient temperature ϑ_{16} (=initial temperature at the beginning of the measurement).
- Operation of the solenoid under the foreseen operating conditions until the steady-state temperature has been reached. Steady-state temperature is reached, if the winding temperature changes by maximum 1K within 60 minutes.
- Measuring of the winding resistance R_w . For this, the device is separated from the voltage source and the resistance is directly measured. (Too long waiting times between separating from the voltage source and measuring result in a cooling down of the coil and thus falsify the result.)

- Calculation of the steady-state temperature ϑ_{23} using the formula:

$$\vartheta_{23} = \vartheta_{16} + 255 (R_w - R_k) / R_k$$

ϑ_{23} = Steady-state temperature, resp. temperature at the end of the measuring (in the coil) (°C)

ϑ_{16} = Initial temperature at the beginning of the measuring (°C)

R_w = Resistance in heated condition (Ω)

R_k = Resistance in cold condition (Ω)

The determined steady-state temperature is to be compared with the upper limit temperature admissible for the thermal class. If the limit temperature is exceeded during the measuring, the trial has to be aborted; if the limit temperature is not reached, a different winding variant is to be considered for the device.

A design by our technicians is made within the scope of the project management.

Warning: The measurement may be performed by skilled staff only.

7.5 Protection classes

According to the protection against electric shock, electromagnetic devices are divided into protection classes I – III to DIN EN 61140 resp. VDE 0140-1 and identified accordingly.

7.5.1 Protection class I – Protective conductor system

Symbol for grounding: 

The symbol stands for the grounding at protection class I, there is no symbol for the protection class I itself.

Besides the basic insulation, the protection against electric shock bases on the fact that all conductive housing parts are connected to the protective conductor of the fixed installation so that if the basic insulation failed, there is no voltage anymore.

For voltages over 120V, the version in protection class I is generally mandatory. Conversely: If a device is classified in protection class I resp. if a protective conductor terminal is in place, a continuous protective conductor connection (PE contacting) is to be performed – regardless of the voltage. A protective conductor terminal to series DIN VDE 0100 shall be provided by the device/connector and ensured accordingly by the user. Plug connections are to be performed with protective earth contact. The insert of the connecting cable into the device must be mechanically strain-relieved.

Special case devices with movable or removable solenoid bodies:

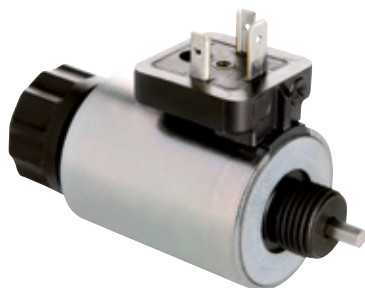

Fig. 41: Valve solenoid hydraulics with removable solenoid body complete



Fig. 42: Tube and solenoid body disassembled

Due to the design of devices with removable solenoid body, they don't have any continuous proper PE conductor connection between protective conductor terminal of the solenoid body and tube.

A proper protective conductor terminal of the tube resp. of the related valve is to be ensured by the user.

7.5.2 Protection class II – Reinforced insulation (Protection insulation)

Symbol for protection class II: 

Protection against electrical shock is based on basic insulation and on additional safety precautions as doubled or reinforced insulation. Even if devices have electrically conducting surfaces, they are protected by the reinforced insulation against contact with live parts. There is no protective conductor terminal.

7.5.3 Protection class III – Protective low voltage

Symbol for protection class III 

Devices of protection class III are to be operated with protective low voltage and may not generate voltages higher than the protective low voltage (ELV= Extra Low Voltage).

By definition, devices of protection class III do not have any protective conductor terminal.

The admissible voltage range for protection class III is $\leq 120V$ for direct voltage (DC), at alternating voltage (AC) $\leq 50V$. (effective value each).

Safety transformers with safe separation of primary and secondary side to DIN VDE 0570-2-6 / DIN EN 61558-2-6 or batteries resp. accumulators are to be used as voltage sources.

Within protection class III (ELV), we distinguish for the voltage sources between

SELV (=Safety Extra Low Voltage) and

PELV (=Protective Extra Low Voltage).

The same voltage ranges (s. above) shall apply for SELV and PELV voltage sources resp. electric circuits.

The significant difference lies in the protective conductor terminal.

SELV electric circuits and components resp. exposed conductive parts must not be connected to the protective conductor resp. grounded.

PELV electric circuits and components resp. exposed conductive parts may be connected to the protective conductor resp. grounded (equipotential bonding).

Typical examples:

- Protection of components against electromagnetic influences (EMC)
- Protection against spark formation in explosion protection
- Equipotential bonding

In normal dry environment, the following shall apply:

With rated voltages higher than 25 VAC resp. 60 VDC, the additional measure basic insulation must be also performed for SELV and also for PELV.

With rated voltages smaller than 25 VAC resp. 60 VDC, basic insulation can be omitted for SELV. For PELV, either basic insulation or protective grounding resp. protective conductor terminal must be in place. Thus, components with existing basic insulation do not have to be grounded.

In special cases, the value of the low voltage in group 700 of series DIN VDE 0100 is limited to a value smaller than 50 VAC resp. 120 VDC.

8. Test of dielectric strength

In order to prove the insulating property of MSM DC solenoids, they are tested at 100% for dielectric strength during a routine test.

8.1 Type and level of the test voltage (U_p)

The test is performed with virtually sinusoidal AC voltage of 50 Hz. Its level depends on the rated voltage.

| | | | | | |
|-----------------------|-----|-----|------|------|------|
| U conductor earth (V) | 50 | 100 | 150 | 300 | 600 |
| U_N (V) | 50 | 100 | 150 | 300 | 600 |
| U_p (V) * | 500 | 800 | 1400 | 2200 | 3300 |

Fig. 43: Table test voltages for device of protection class I and III (for class III only up to $U_N=120V$ or $\sim 50V$)

U_N (V) = rated voltage

U_p (V) = test voltage (effective value of the alternating voltage, over-voltage category III)

*Interpolations are admissible

8.2 Performance of the voltage test

The voltage test with U_p is to be applied between excitation winding and the exposed metal parts of the device. If there are several separated excitation windings, all these windings are to be tested for dielectric strength against each other and against the exposed metal parts. The test voltage is applied in full and applied to the specimen for about 1 sec.

The test is considered as passed, if neither breakdown nor flashover occurs. Corona phenomena which do not result in flashovers are not considered.

8.3 Repeated voltage test

The voltage test performed during the routine testing should not be repeated if possible. A second test to be performed on special request – e.g. on acceptance – may be only performed with 80 % of the values indicated in the table. Here, the admissible interpolation of the test voltages is to be applied.

9. Rated operating conditions

MSM DC solenoids are designed for the following normal operating conditions resp. ambient conditions:

Limit deviations of the rated voltage to DIN EN 60038 (VDE 0175-1)

9.1 Ambient temperature does not exceed 40° C and its average value does not exceed 35° C over a period of 24 hours. The lower limit temperature is –5° C.

9.2 Altitude of the place of use is not more than 1000 m above sea level (NN).

For bigger altitudes, cooling is reduced due to the lower density of the air. If the winding is not adapted accordingly, there is the risk of thermal overload of the device.

9.3 The Ambient air should not be considerably polluted by dust, smoke, aggressive gases and vapours or salt content.

9.4 The relative humidity of the ambient air shall not exceed 50 % at 40°C. For lower temperatures, a higher humidity can be admitted, e.g. 90 % at 20° C.

Occasional moderate condensation is to be taken into consideration, by corrosion protection / surface coating; drain holes.

9.5 For installation of the devices, the **Installation guidelines and the Safety instructions (section 16.1)** are to be observed.

9.6 If there are **deviations** from these normal **operating conditions** in practise, so respective measures as higher protection class, special surface protection etc. are to be taken. In such cases, we ask you to please consult us and to indicate the present operating conditions.

10. Service life

The **service life of the devices** and the service life of the wear parts of electromagnetic devices does not only depend on the design but also to a large extent on external conditions as installation position, type and level of loads. Thus, statements about the service life must be reserved for the agreement between the customer and MSM.

11. Electrical Connection of DC Solenoids

11.1 DC connection (Fig. 44)

The DC connection is made directly to the voltage source.

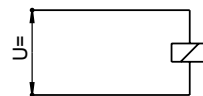

Fig. 44: Circuit diagram solenoid DC connection

11.2 AC connection (Fig. 45)

If no DC voltage is available, the connection of the DC solenoid is made by a rectifier, ideally by a Graetz bridge switching.

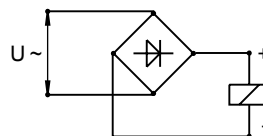

Fig. 45: Circuit diagram solenoid AC connection

If mains voltage is ~ 230 V, the DC solenoid must be designed for 205 V using a silicon rectifier.

Depending on the device type, there are different possibilities to integrate the rectifier in or on the device:

- Factory-made installation of the rectifier in the terminal box
- Rectifier installed in connector plug, connector plug with rectifier can be purchased as accessories.

Furthermore, other solutions are conceivable; please contact us, if you are interested.

11.3 Connection of DC solenoids via an electrical control device



Fig. 46: Control device holding current reduction Z KD H

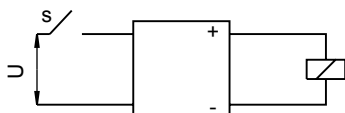

Fig. 47: Circuit diagram electronic control device

By the operation of a solenoid via an electronic control device, there is the possibility to optimise the solenoid drive in several directions:

- Reduction of switching times (see sect. 6.2)
- Maximising of attraction force with the smallest possible device size
- Improvement of energy efficiency and reduction of heat development

Optimisation is achieved, if the electrical power applied at the magnetic coil is reduced after having reached the end position. Normally, this is controlled by a timer; solutions where the position of the armature is requested can be realised as special solution if required.

When using a pre-pilot device, we recommend taking care that it is provided with a holding current control. Thus, it is guaranteed that the set holding force remains constant over the whole operating temperature range.

11.3.1 Maximising of the attraction force

As explained in chapters Operating modes (section 4.8) and Temperatures (section 7), the electric power installable in the solenoid resp. the permitted duty cycle depends on how fast the solenoid reaches the admissible excessive temperature. Whereas with the direct connection of a solenoid (section 11.1), nearly the same power is absorbed by the magnetic coil during the whole running time, a pilot control device offers the possibility to reduce the power after having reached the end position.

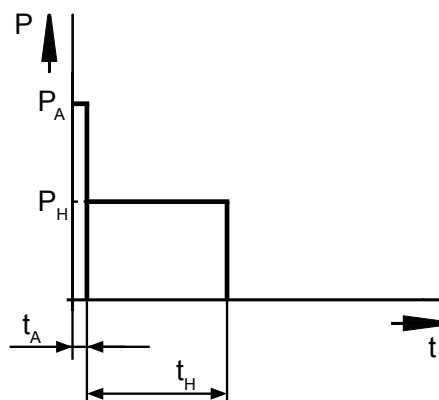

Fig. 48: Attraction and holding power

t_A : attraction time

t_H : holding time

P_A : attraction power

P_H : holding power

If the attraction force of a solenoid shall be increased by means of a pilot control device, it is required that the plant equips the device with a winding which is adapted to the application. The investments for design and production of the adapted device entail that this solution is economically feasible for notable requirements only.

If you have identified any potential in your application, please contact us, we are pleased to advise you.

11.3.2 Optimisation of energy efficiency and reduction of heat development

In principle, solenoids of MSM are trimmed to optimum energy utilisation from the constructive and the qualitative point of view.

In order to operate a solenoid in an energy-efficient manner, you must be aware that its efficiency tends inevitably to zero as soon as the solenoid has reached its end position and does not perform a movement anymore.

At the same time, the solenoid reaches its maximum force, holding force F_H (Fig. 49) in the end position. Normally, this holding force is higher than required.

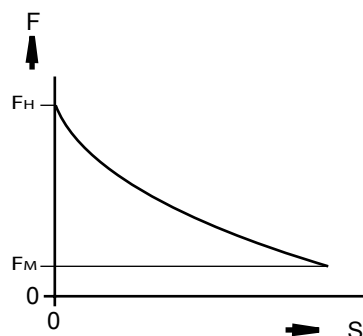

Fig. 49: Increasing characteristic

By the application of a suitable pilot device (holding current reduction), the holding current is reduced to the extent that the holding force sufficient for the application is reached, the holding power is therefore reduced to the required minimum.

If you have identified any potential in your application, please contact us, we are pleased to advise you.

12. Note to Elimination of Disconnect Overvoltage and Spark quenching

12.1 Elimination of disconnect over-voltages

The inductance, which the DC solenoid is subjected to, causes high disconnect over-voltages - particularly at bigger solenoids - which may cause damages of the electric insulation and of electronic components.

The following measures are recommended for damping of the disconnect overvoltage:

12.1.1 Damping by varistors (voltage depending resistances) (Fig. 50)

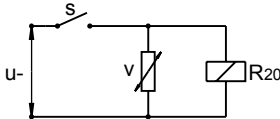

Fig. 50: Circuit diagram damping by varistors

Varistor V is designed to have a very high resistance at rated voltage U and thus carries only small current with closed switch S. The resistance of the varistor reduces considerably when disconnect overvoltage occurs which damps the latter. Fall time is only little delayed.

12.1.2 Damping by mains rectifier (Fig. 51)

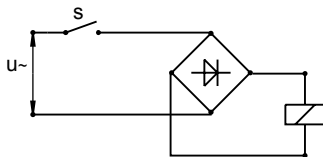

Fig. 51: Circuit diagram damping by mains rectifier

During AC switching, the disconnect over-voltage is completely damped, but the armature drop is seriously delayed.

12.1.3 Damping by diodes

For the selection of suitable diodes, it must be noted that they withstand the operating voltage and the rated current of the solenoid. The response delay t_{21} is extended with decreasing breakdown voltage of the diode.

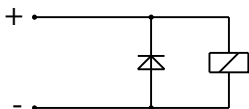

Fig. 52: Circuit diagram damping by free-wheeling diode

When using a free-wheeling diode, particular consideration shall be given to the polarity of the connection voltage.

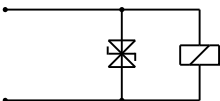

Fig. 53: Circuit diagram damping by bi-directional TVS diode

When using a bi-directional TVS diode, the polarity of the connection voltage is unimportant.

12.2 Spark quenching

The high disconnect overvoltage causes electric arc and thus combustion of the contacts and material migration at the used switches, provided that no spark extinguishing agent are provided.

Spark quenching by means of varistors and RC element is the most common spark extinguishing agent. (Fig. 54)

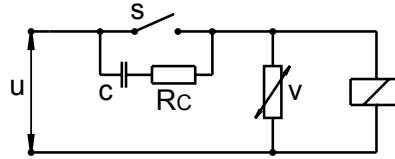

Fig. 54: Circuit diagram spark quenching by means of varistors and RC element

By varistor V, the disconnect overvoltage is damped to the peak voltage of the used capacitor. The RC element positioned in parallel to the switching contact effects that the voltage occurring at the contact does not exceed the minimum voltage of electric arc which thus prevents the occurrence of an electric arc.

13. Electromagnetic Time constant (τ) and Inductances

For determination of the inductances of the DC high performance solenoids, the electromagnetic time constants are partly indicated in the lists in stroke start position of the armature. From these time constants, the inductances for the different operating modes and supply voltages can be determined using the following example:

Given: Solenoid type G TU W 070

ED = 25 %

Rated voltage = 180 V

Wanted:

Inductance L_1 (H) in stroke start position of the armature

Inductance L_2 (H) in stroke end position of the armature

Solution:

Rated power from list:

$$P_N = 142 \text{ W}$$

The resistance of the excitation winding to R results from rated power:

$$R = \frac{U^2}{P_N} = \frac{180^2}{142} = 228 \ \Omega$$

Inductance in stroke start position

$$L_1 = \tau_1 \times R = 20 \times 10^{-3} \times 228 = 4,5$$

Inductance in stroke end position

$$L_2 = \tau_2 \times R = 18 \times 10^{-3} \times 228 = 4,1$$

It should be ensured that in this calculation, the time constants are stated in seconds, i. e. the values of the time constant specified in the list must be multiplied by 10^{-3} .

14. Order specifications for DC solenoids

Standard devices from the MSM programme are clearly defined by the following specifications:

- Type
- Voltage
- Operating mode (% ED)

All other technical data are listed in the respective part list.

If your application cannot be covered by our standard programme, we ask you to please contact us for the agreement of a requirements specification. We are pleased to work out a solution for your task.

Our checklist solenoid technology which can be downloaded from our homepage contains information about the required specifications.

15. Installation guidelines for DC solenoids

15.1 General

Please make sure that the device to be installed is suitable for your application.

Please note DIN VDE 0580, relevant standards, regulations and the safety instructions section 16.1.

Devices without Ex marking (see type plate) must not be applied in explosive areas.

Information and remarks concerning European directives can be taken from the correspondent information sheet which is available under *Produktinfo.Magnet-Schultz.com*.

15.2 Working position

MSM DC solenoids can be applied in any installation position.

15.3 Installation

The solenoid armature is to be connected to the machine part to be actuated in such suitable way that no constraining forces result from misalignments.

Assembly resp. fastening of the solenoids only via the intended bores/threaded holes. The specified screw lengths, screw-in depth and tightening torques are to be respected (see technical data sheets).

The electrical connection is to be performed after completion of the mechanical fastening.

A protective conductor terminal existing at the device is to be connected to series DIN VDE 0100 and permanently ensured by the user. See also section 7.5.1 Protection class I - Protective conductor system.

In principle, shocks on the armature rod and on the solenoid are to be avoided.

Furthermore, it shall apply for:

- a) Linear solenoids
In the interest of the service life of the bearings, it has to be ensured that for linear solenoids, no external forces influence armature or armature rod in axial direction.
- b) Rotary solenoids
In order to increase the service life of rotary solenoids, it is appropriate to keep mass forces away from the internal stops by external rotation angle limitations.

15.4 Initial operation

The compliance with rated voltage, duty cycle, ambient temperature range and requirements from the protection class are to be checked before initial operation of the electromagnetic device.

Solenoids are no ready-for-use devices in the sense of DIN VDE 0580.

15.5 External counter-forces

All solenoids should use at least 2/3 of their magnetic force. Thus, sticking of the armature is avoided for certain.

If the solenoid has to overcome external spring forces, a solenoid should be selected such that the spring characteristic can be adapted to the magnetic force vs. stroke characteristic.

15.6 Electrical protection (Protective circuit by fuse)

The power consumption in ampere is calculated on the basis of

$$I = \frac{P}{U}$$

P = rated power (W), U = rated voltage (V), I = current (A)

After the current has been determined, the respective fuse can be chosen.

15.7 Voltage drop and wire cross-section

The required rated voltage must be fed to the solenoids. When laying the cabling, the voltage drop should be kept within narrow limits by correct cross section measuring of the cables (normal up to 5 %).

15.8 Protection against contact

Protection against contact resp. protection against electric shock is to be ensured by the user.

15.9 Maintenance

MSM DC solenoids work maintenance-free when properly used.

We, however, recommend performing a regular visual inspection and functional test under consideration of the following points:

- **For all maintenance works, the safety instructions section 16.1 are to be observed**
- General visual inspection with regard to completeness, damages and manipulations of any kind
- Fastening / firm seat
- Cleanliness:
Keep solenoids free from deposits, grease and oil residues; control for abrasion and corrosion; (danger of bearing damages, functional limitations, overheating, fire hazard)
- Signs of unauthorised ingress of humidity and liquids
- Electrical connection:
Damages at electric supplies, insulations and encapsulation of solenoid body
- Smooth operation of the armature
- Pole surfaces of holding solenoids clean and free from mechanical damages (reduction of the holding force)
- Signs of overheating (deformation and discoloration of insulators)
- Condition of corrosion protection
- Impact of the heat dissipation needed for operation

15.10 Disassembly and Disposal

Devices may only be disassembled in de-energised condition. DC solenoids are not subject to directive WEEE. Disposal is to be professionally performed compliant with the current guidelines, regulations and laws.

16. Safety

16.1 Safety instructions







| | |
|---|---|
|  | Warning of electrical voltage |
| | <p>Any operation at electrical components and facilities, as well as opening of terminal boxes, control cabinets or similar is to be carried out by qualified electricians only.</p> <p>Contact with live parts can cause fatal injuries.</p> <p>Works at device and power supply shall be carried out in de-energised condition only (activate, secure against restart, verify that no voltage is present).</p> |
|  | Warning of hot surface |
| | <p>Contact with magnetic devices may result in burns.</p> <p>An increased surface temperature must be expected.</p> <p>Depending on the application, the magnitude of the limit temperature may be reached, e.g. thermal class F: 155°C.</p> |
|  | Warning of hand injuries |
| | <p>By the installation of the device in the application and depending on the design, there may be a risk of injury through squeezing and shearing by movable parts when actuating the solenoid.</p> <p>Danger zones are to be safeguarded according to the relevant applicable standards and regulations (e.g. machinery directive).</p> |
|  | Warning of injuries caused by transport and handling |
| | <p>Depending on the size, some solenoids have a significant weight.</p> <p>Please note for handling and transport the relevant regulations regarding accident prevention and occupational safety as well as cargo securing.</p> |
|  | Warning of magnetic field |
| | <p>For devices with open magnetic circuit, as holding solenoids and permanent holding solenoids, magnetic fields can leak out.</p> <p>If the devices are taken close to cardiac pacemakers or implanted defibrillators, this may lead to life-threatening situations.</p> <p>Keep the devices away from objects which react sensitively to magnetic fields, e.g.: bank cards with magnetic strip, audio and data tapes, mechanical watches.</p> |
|  | External interventions or changes |
| | <p>Changes or manipulations lead to the loss of guarantee on the part of MSM and may cause malfunctions of the solenoid and unpredictable hazards.</p> |

Fig. 55: Table warnings

16.2 Note on functional safety to EN ISO 13849, EN/IEC 61508 and ISO 26262

Systems and machines must comply with the legal requirements regarding safety and reliability. Manufacturers are obliged to perform a risk evaluation and to take risk minimising measures. The limit values to be met are defined with information on performance level (PL) or safety integration level (SIL).

DC solenoids are incomplete components which have no autonomous function. A risk evaluation in the final application resp. for the intended application case indicating PL or SIL values cannot be performed for these components.

The reliability of electromagnetic components is described by service life specifications (TL) depending on application or test conditions.

Notes on MTTF or B10 values for proven components can be taken from the respective tables of EN ISO 13849-2.

Terminology:

MTTF: **(Mean Time To Failure)** average time to failure

B10: number of cycles until 10% of the tested components has failed.

TL: **(Life Time)** service life

17. Device Protection Classes (IP Protection Class)

Device protection classes to DIN EN 60529 (VDE 0470-1) are each indicated on the data sheets. Deviations thereof are delivered on request.

For electromagnetic devices, the specific feature is that different protection classes can be indicated for the device and the electrical connection resp. the exciter coil.

The protection class at delivery may differ from the protection class which can be achieved in the properly mounted condition, i.e. generally the protection class is only reached, if the connector indicated in the part list has been professionally mounted.

17.1 Designation protection classes

Designation of protection classes is made according to the following table

| | | |
|---|---|--|
| IP | 6 | 5 |
| | | 2 nd indicator Protection against water |
| | | 1 st indicator Protection against access to hazardous parts and protection against solid foreign objects |
| Indicator (international protection) | | |

Fig. 56: Table designation protection classes

17.2 Degrees of protection

The degrees of protection result from the combination of first or second indicator.

| First indicator | Degree of protection against the access to hazardous parts and degree of protection against solid foreign objects | |
|-----------------|--|--|
| | Short description | Definition |
| 0 | Not protected | - |
| 1 | Protected against access to hazardous parts with the back of the hand and protected against solid foreign objects with diameter 50 mm and bigger | The access probe, ball with diameter 50 mm, must have sufficient distance from hazardous parts and the object probe, ball with diameter 50 mm, must not fully penetrate |
| 2 | Protected against access to hazardous parts with one finger and protected against solid foreign objects with diameter 12.5 mm and bigger | The jointed test finger with diameter 12 mm, 80 mm length, must have sufficient distance from hazardous parts and the object probe, ball with diameter 12.5 mm, must not fully penetrate |
| 3 | Protected against access to hazardous parts with a tool and protected against solid foreign objects with diameter 2.5 mm and bigger | The access probe and the object probe with diameter 2.5 mm each must not penetrate at all |
| 4 | Protected against access to hazardous parts with a wire and protected against solid foreign objects with diameter 1.0 mm and bigger | The access probe with diameter 1.0 mm must not penetrate |
| 5 | Protected against access to hazardous parts with a wire and dust proof | The access probe with diameter 1.0 mm must not penetrate. Penetration of dust is not completely prevented, but dust must not penetrate in such quantity that the satisfying work of the devices or the safety is impacted |
| 6 | Protected against the access to hazardous parts with a wire and dust-tight | The access probe with diameter 1.0 mm must not penetrate. No penetration of dust |

Fig. 57: Table IP protection class indicator 1

| Second indicator | Degrees of protection against water | |
|------------------|---|---|
| | Short description | Definition |
| 0 | Not protected | - |
| 1 | Protected against dripping water | Vertically falling drops must not have any harmful effects |
| 2 | Protected against dripping water, if the housing is inclined up to 15° | Vertically falling drops must not have any harmful effects, if the housing is inclined by an angle up to 15° on either side of the vertical |
| 3 | Protected against spray water | Water, that is sprayed in an angle of up to 60° on either side of the vertical, must not have any harmful effects |
| 4 | Protected against splash water | Water, that splashes against the housing, from any direction must not have any harmful effects |
| 5 | Protected against water jets | Water jets directed from any direction against the housing, must not have any harmful effects |
| 6 | Protected against strong water jets | Strong water jets directed from any direction against the housing, must not have any harmful effects |
| 7 | Protected against the effects of temporary immersion in water | Water may not ingress in a volume that would cause harmful effects, if the housing is temporarily immersed in water under standardised pressure and time conditions |
| 8 | Protected against the effects of continuous immersion in water | Water may not ingress in a volume that would cause harmful effects, if the housing is continuously immersed under conditions which have been agreed between manufacturer and user. The conditions, however, must be more difficult than for indicator 7 |
| 9K ¹⁾ | Protected against water at high-pressure/steam-jet cleaning ¹⁾ Indicator to DIN 40050 Part 9 road vehicles protection classes | Water that is directed from each direction against the housing under strongly increased pressure must not have any harmful effects |

Fig. 58: Table IP protection class indicator 2

17.3 Solenoids for application under special conditions as

- in extremely humid atmosphere
- in tropical version
- in radioactive rooms and in nuclear technology
- for aggressive ambient conditions
- in explosive areas
- medical applications
- automotive applications
- aerospace applications

etc. are delivered on request.

18. Regulations, Standards und Provisions (state 6/2017)

| | |
|-----------------------------|--|
| DIN 1304-1 | Symbols - General symbols |
| DIN 40050-9 | Road vehicles; IP protection classes; protection against foreign objects, water and contact; electrical equipment (cancelled) |
| DIN 46008 | Connection surfaces for grounding and protective conductor terminal screws – rated voltage below 52 KV |
| DIN EN 50274 (VDE 0660-514) | Low-voltage switching device combinations - protection against electric shock – protection against unintended direct contact with hazardous live parts |
| DIN EN 60038 (VDE 0175-1) | Cenelec standard voltages |
| DIN EN 60085 (VDE 0301-1) | Electrical insulation – thermal evaluation and designation |
| DIN EN 60204-1 (VDE 0113-1) | Safety of machines – electrical equipment of machines - part 1: general requirements |
| DIN EN 60529 (VDE 0470-1) | Protection classes by housing (IP-Code) |
| ISO 20653 | Road vehicles - protection classes (IP-Code) - protection against foreign objects, water and contact - electrical equipment |
| DIN EN 60617 (series) | Graphic symbols for wiring diagrams |
| DIN EN 60664-1 (VDE 0110-1) | Insulation coordination for electrical equipment in low-voltage systems - part 1: principles, requirements and tests |
| DIN EN 60999-1 (VDE 0609-1) | Connecting material – electric copper conductor – safety requirements for screw-type and screwless-type clamping units - part 1: general requirements and specific requirements for clamping units for conductor of 0.2 mm [2] up to and including 35 mm [2] |
| DIN EN 61140 (VDE 0140-1) | Protection against electric shock – general requirements for plants and equipment |

DIN EN 61558-2-6 (VDE 0570-2-6)

Safety of transformers, throttles, power supplies and the like for supply voltages up to 1100 V - part 2-6: special requirements and tests at safety transformers and power supplies containing safety transformers

DIN EN ISO 7010

Graphic symbols – safety colours and safety marks - registered safety marks

DIN VDE 0100-410

Setting-up of low-voltage systems - part 4-41: protective measures - protection against electric shock

DIN VDE 0100-420

Setting-up of low-voltage systems - part 4-42: protective measures - protection against thermal effects

DIN VDE 0100-520

Setting-up of low-voltage systems - part 5-52: selection and setting-up of electrical equipment – cable and wiring systems

DIN VDE 0100-540

Setting-up of low-voltage systems - part 5-54: selection and setting-up of electrical equipment – grounding systems and protective conductors

DIN VDE 0580

Electromagnetic devices and components - general provisions

DIN EN ISO 13849

Safety of machines – safety related parts of control devices

IEC 61508

Functional safety of electrical/electronic/programmable electronic safety-related systems

ISO 26262

Road vehicles - functional safety

Note: Due to updates, there may be changes in the cited standards.